



Demisters

OVERVIEW

Effective separation of vapour and liquid is a primary requirement for efficient industrial processing. With a vast range of fluids, physical properties, pressures, temperature and flow-rates to cover, HAT's **AlphaMIST™** mist eliminators offer effective separation across the board.

Impingement Types:



HE/GP/DS Mesh Demisters
Available in a range of metal alloys



HE/GP/DS Mesh Demisters
Also available in plastics, glass wool and dual media construction

Momentum Types:



VV Vane Mist Eliminators
Plain style for vertical gas flow or fouling applications



VH1/VH2 Vane Mist Eliminators
Hooked and pocketed designs for improved efficiency & performance

Cyclone Types:



SME Swirl Mist Eliminator
An axial flow, swirl cyclone with very high capacity



SME Mist Eliminator in GRP
A unique, low cost alternative suits many applications



MCE Multi Cyclone Bundle
An effective device for the separation of high levels of liquids and solids in a single stage



Demisters

Application

HAT's **AlphaMIST** mesh pad type mist eliminators remove droplets by impingement on the wire surface. The liquid collected on the filaments is then able to drain from the pad under gravity. They have a limited range of useful operation in which they provide almost complete removal of droplets down to about 3-5 microns. Turndown range of vapour rate is around 3:1. At excessively high vapour velocities, the liquid droplets that impinge on the wire surface are sheared off by the vapour and re-entrained before they are able to drain. At very low vapour velocities, all but the larger droplets are able to follow the vapour path through the mesh and thus avoid impingement; however the inherent design of the separator vessel means that in most applications an effective turndown performance of 10:1 can be achieved.

Wire mesh mist eliminators are well suited to remove mechanically formed entrainment from packed and trayed process towers, spray columns, venturi scrubbers and other gas scrubbing devices. They are also a widely used de-entrainment device in knock out drums and separators.

General Configuration

AlphaMIST mesh demisters consist of a pad of knitted metal or plastic wire mesh usually sandwiched between grids for mechanical support. Except for units less than about 600mm diameter, they are normally split into sections of between 300 to 400mm wide to facilitate installation through a normal vessel manway. The pads are cut slightly oversize to ensure a snug fit and thus eliminate any possible vapour by-pass either between sections or between pad and vessel wall (or shroud). Each mesh pad is formed from crimped layers of fabric knitted from monofilament with the direction of the crimp rotated 90 degrees in each adjacent layer to provide a uniform voidage together with a high ratio of filament surface per unit volume of pad.

Standard support grids consist of a framework of 25mm x 3mm thick flat bar fixed to a grid consisting of 6mm rods usually spaced on 150mm centres to retain the mesh with minimum obstruction of the face of the pad. The top and bottom grids are connected by spacer rods passing through the mesh that are welded to each grid to ensure the dimensional stability of the pad. Mesh pads can also be furnished with special heavy duty support grids where these are required to provide a working platform inside the vessel.

AlphaMIST mesh pads can be installed either horizontally for vertical vapour flow or vertically for horizontal vapour flow. For vertical vapour flow, mesh pads are normally either 100mm or 150mm thick and for horizontal flow are normally greater at 150 to 200mm+ thick. Where mesh pad thickness exceeds 300mm, the unit is usually divided into 2 separate layers so that the sections will pass through normal vessel manways and in such cases wire screens are fitted between layers to maintain pad integrity during installation.



Demisters

Specification

AlphaMIST mesh mist eliminators are manufactured in a wide variety of metals and synthetics of which the following are supplied as standard:-

Stainless steels (types 304, 304L, 316, 316L, 321, 430)

Monel

Nickel & nickel alloys

Copper & copper alloys

Glass wool or fibre

Polypropylene

Halar / PTFE

The wire mesh may be knitted and formed to provide a wide range of specific properties to suit various applications. The following is a list of standard mesh styles that we supply:-

STYLE	APPLICATIONS
HE	High efficiency removal of fine mists
GP	General purpose (maximum efficiency with low pressure loss)
DS	Dirty service where fouling is an issue



Demisters

For optimum designs the K-factor should be modified to take into account the operating pressure, liquid viscosity, surface tension, liquid entrainment, etc, so please confirm sizing against HAT's proprietary design program.

Typical Arrangement

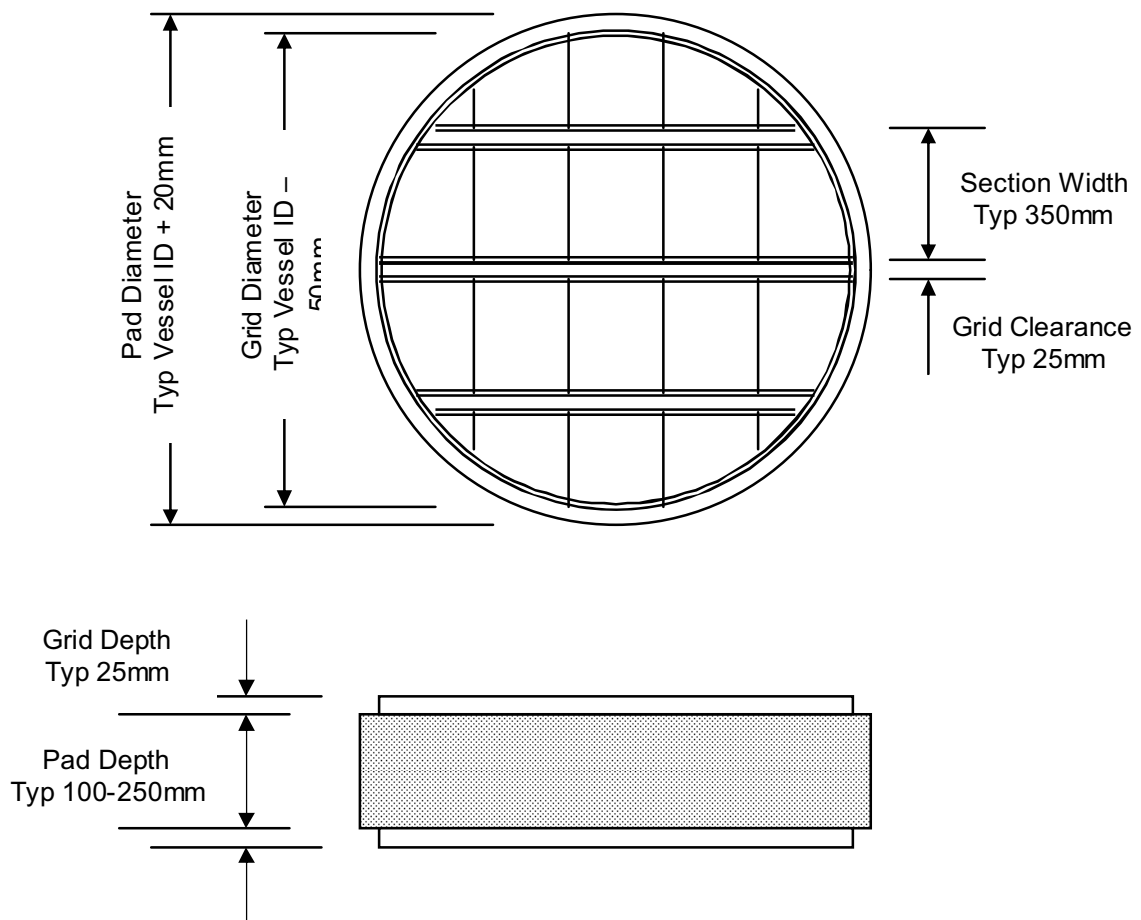



Mesh Demisters

AlphaMIST™ MESH SPECIFICATION CHART

Style	Materials	Application	Wire Diameter mm	Mesh Density kg/m ³	Surface Area m ² /m ³	Voidage %	Nominal Micron Rating*
HE-1M	Metals	Very high efficiency in clean service	0.15	195	650	97.5	3 μ
HE-2M	Metals	Fine droplet removal in clean service	0.15	145	480	98.2	4 μ
HE-3M	Metals	General purpose, clean service	0.15	112	375	98.6	5 μ
GP-1M	Metals	Optimum efficiency & pressure drop	0.275	195	355	97.6	5 μ
GP-2M	Metals	General purpose, not totally clean	0.275	170	310	97.9	6 μ
GP-3M	Metals	Heavy duty e.g. oil & gas separators	0.275	145	265	98.2	8 μ
DS-1M	Metals	Light fouling	0.275	110	200	98.6	10 μ
DS-2M	Metals	Moderate fouling	0.275	80	145	99.0	12 μ
DS-3M	Metals	Heavy fouling e.g. evaporators	0.275	50	90	99.4	15 μ
HE-1G	Glass Wool	Very fine mists	0.20	195	1500	92.5	2 μ
HE-2G	Glass Wool	Fine mists	0.20	135	1000	94.8	3 μ
HE-1P	Polypropylene	Acid mists	0.25	75	1120	93.0	3 μ
HE-1X	Metal/PP Mix	Mist removal of polar and non-polar mixtures	0.275/0.25	200	625	95.6	5 μ
GP-1P	Polypropylene	Chemical scrubber towers	0.25	50	750	95.3	6 μ
GP-1T	Teflon	Very corrosive services	0.25	64	480	97.0	8 μ
DS-1P	Polypropylene	Low pressure drop e.g. air scrubbers	0.25	33	490	96.9	10 μ

* 99% Removal at optimum velocity through a 150mm pad



Vane Mist Eliminators

Vane mist eliminators consist of a series of plates or vanes spaced to provide passage for vapour flow and profiled with angles to provide sufficient change of direction for liquid droplets to impact, coalesce and drain from the surfaces of the plates. HAT design and manufacture a range of **AlphaMIST™** vane styles which provide the following benefits:

- High vapour capacity
- Resistance to fouling
- Low pressure loss
- Effective removal of high liquid loads

The **"VV" Range** is a plain, non-pocketed style designed for larger droplet removal from vapour in normal, light fouling applications with either vertical or horizontal gas flow.

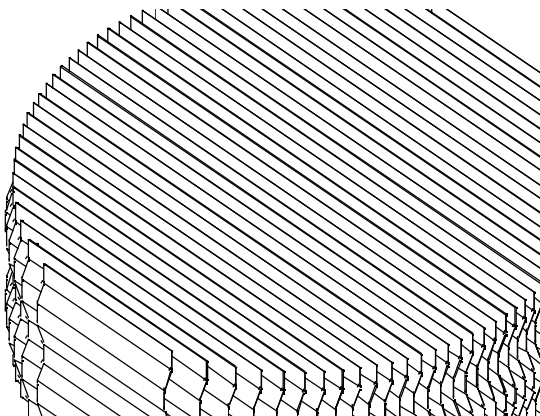

AlphaMIST "V-V" Droplet Separator

The **"VH" Range** is designed for droplet removal from vapour flowing horizontally. In this configuration, the vanes are fitted with hooks (VH11) or pockets (VH-2) to trap and drain the collected liquid. They are generally effective at higher vapour velocities at

which smaller droplet size removal can be achieved.

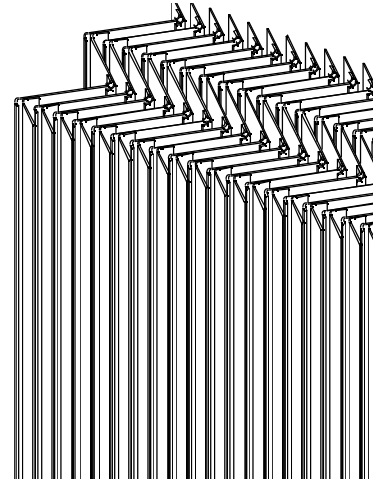

AlphaMIST "VH-1" Droplet Separator

Both of the above styles can be supplied in sections for installation through vessel manways to be supported on full annular support rings welded to the vessel wall. Alternatively they can also be supplied as complete **"Vane Packs"** where the vanes are enclosed in a **Frame** which is flanged for direct attachment to a "gas box".

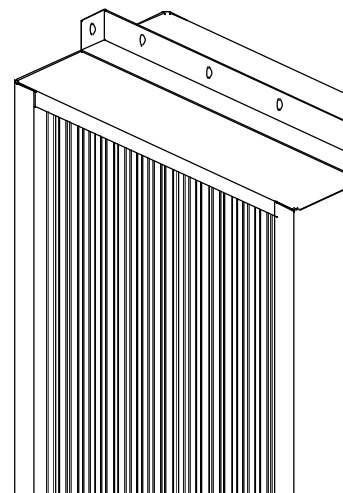

AlphaMIST "VH-1-F" Droplet Separator



Vane Mist Eliminators

The "VV" Range

The AlphaMIST VV is an efficient style of vane mist eliminator commonly used for removing entrained liquid from vapour flowing vertically upwards, and for fouling services. In this configuration, liquid droplets impinge and coalesce on the vanes as the vapour flow is deflected around the vane profile. The liquid collected on the vanes drains downwards under gravity so long as the vapour velocity is not high enough to cause re-entrainment. The graph overleaf shows the relationship between vapour rate and the droplet size range which is effectively removed (typically 99% removal).

Vane assemblies are fabricated in sections sized to fit through vessel manways. Generally they are supported on an annular ring welded to the vessel wall with additional midspan supports being required where the vessel diameter exceeds approx 1000mm. Hold down bars should be fitted to cleats welded to the vessel wall to secure the pack.

The principal applications for this style of droplet separator are the removal of coarse entrainment with high liquid load and also services of a fouling nature. For severe fouling duty e.g. containing dust, the unit could be installed together with a spray system designed to wash out collected solids.

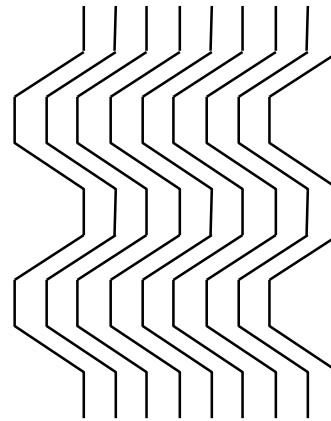

Gas & Mist Flow

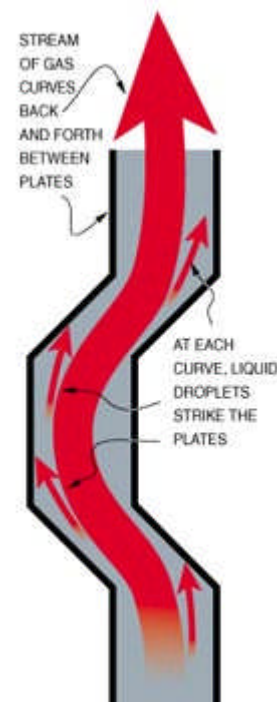



Vane Mist Eliminators

The "VH" Range

The AlphaMIST VH is a vane pack for efficient droplet removal and resistance to fouling suitable for high rate horizontal vapour flow. Entrained liquid droplets impinge on the vanes and collect in pockets that trap the coalesced liquid which then drains from the unit rather than being blown through by the vapour. Collection efficiency is a function of both vapour velocity and the difference in density between the vapour and liquid. The graph below shows the relationship between vapour rate and the droplet size range which is effectively removed (typically 99% removal).

HAT offers a hooked (VH-1) design as standard and a pocketed (VH-2) design for more arduous applications in clean service.

VH vane packs are fabricated in sections sized to fit through vessel manways.

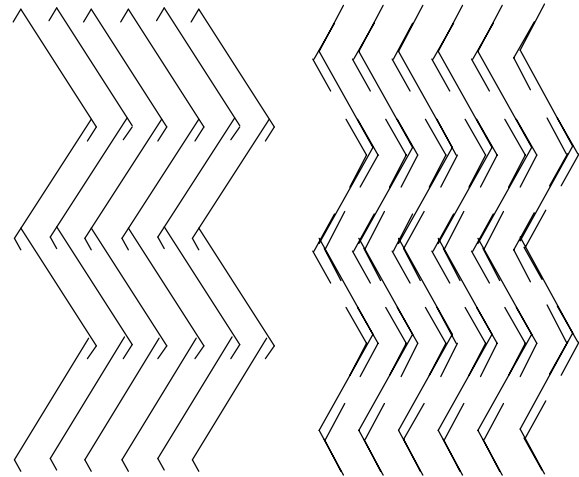

AlphaMIST "VH-1" and "VH-2"

The installation arrangement should ensure that the vane pack is clamped to a ledge and effectively prevents vapour from bypassing the vanes. To achieve this, the VH is normally supplied mounted inside a suitable frame as a VH-F unit with a drainage channel and flanged for mounting to a suitable plate or gas box inside the process vessel.

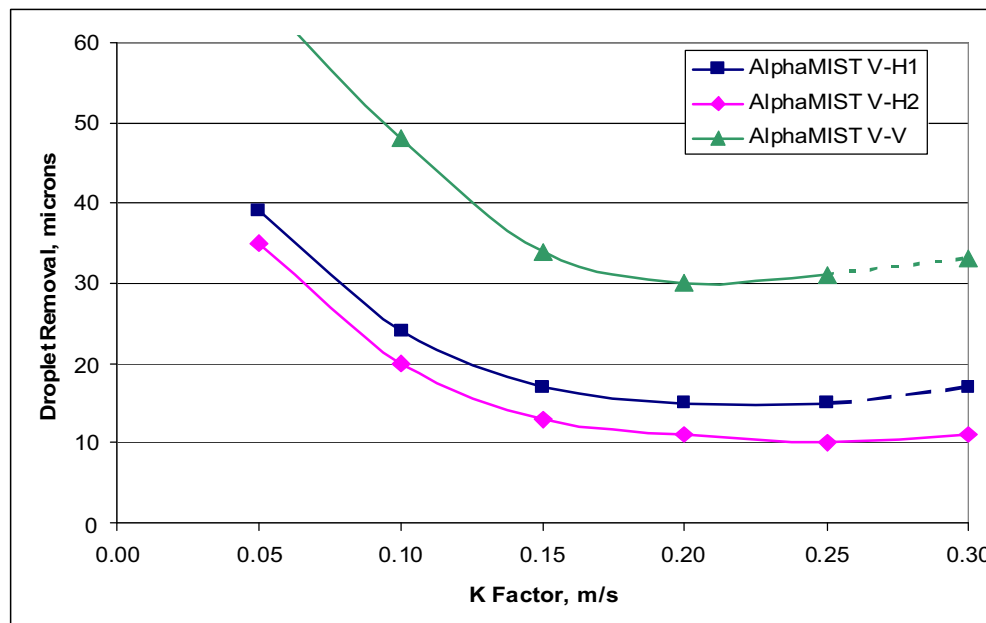



Swirl Mist Eliminator

Introduction

The HAT AlphaMIST Highspeed™ Swirl Mist Eliminator is designed specifically for high efficiency liquid-gas separation for very high gas and liquid capacities.

The design combines high gas velocity, high liquid capture capacity and low to medium pressure drop.

The advantages of the AlphaMIST Highspeed SME's are:

- Highly efficient separation of droplets above 10 microns, even at high pressures
- Very high gas and liquid capacities at high gas velocities
- The mist may contain solid particles
- The Highspeed SME is foam-breaking due to its special construction
- Low or medium pressure drop (10-30 mbar)
- Reduce the vessel size and weight especially in high pressure applications
- High flexibility (turndown) in combination with mesh demister
- Easy to install
- Retrofits easily into existing vessels / scrubbers to give extra capacity
- The unit has no moving parts and is maintenance free

Highspeed SME Applications

The Highspeed swirl mist eliminator provides optimal performance of mist elimination or entrainment separation at high gas capacities and pressures from 10 up to 200 bar. Common applications include:

- Glycol and amine mist eliminators in HP gas treaters
- Droplet removal from distillation or absorber towers
- KO Drums and separators
- Compressor suction and discharge scrubbers
- High velocity discharge vents

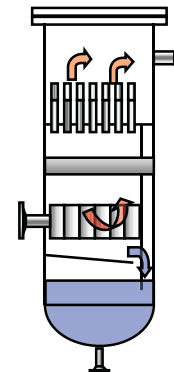



Swirl Mist Eliminator

Highspeed SME Construction

The installed unit consists of special separating elements fixed on a tray with openings for draining the separated liquid. Where low turndown is required (below approx 30%) it can be used with with a wire mesh pre-coalescer.

Each separating element consists of an outer tube with integral swept inlet nozzle fitted with a special swirler internally. In this region the gas and liquid droplets are accelerated at high speed into a cyclonic swirl so that the liquid droplets are flung to the tube walls where they impinge and are swept upwards with the gas. The top of this element is supplied with a centrifugal separator cap which captures the liquid and sends it falling to the tray deck outside the element tube.

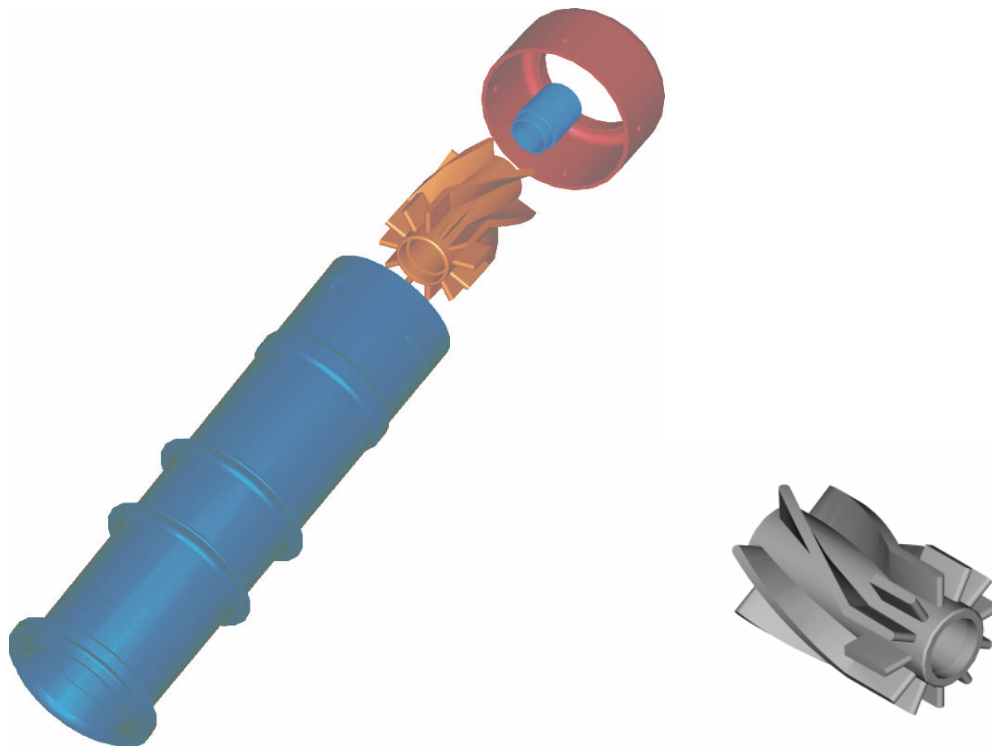

Exploded View of Highspeed SME

The Highspeed SME elements are available in a range of materials including low cost/weight glass reinforced plastics, stainless steels, and high wear resistant ceramics.



Swirl Mist Eliminator

Capture Efficiency vs. Droplet Size

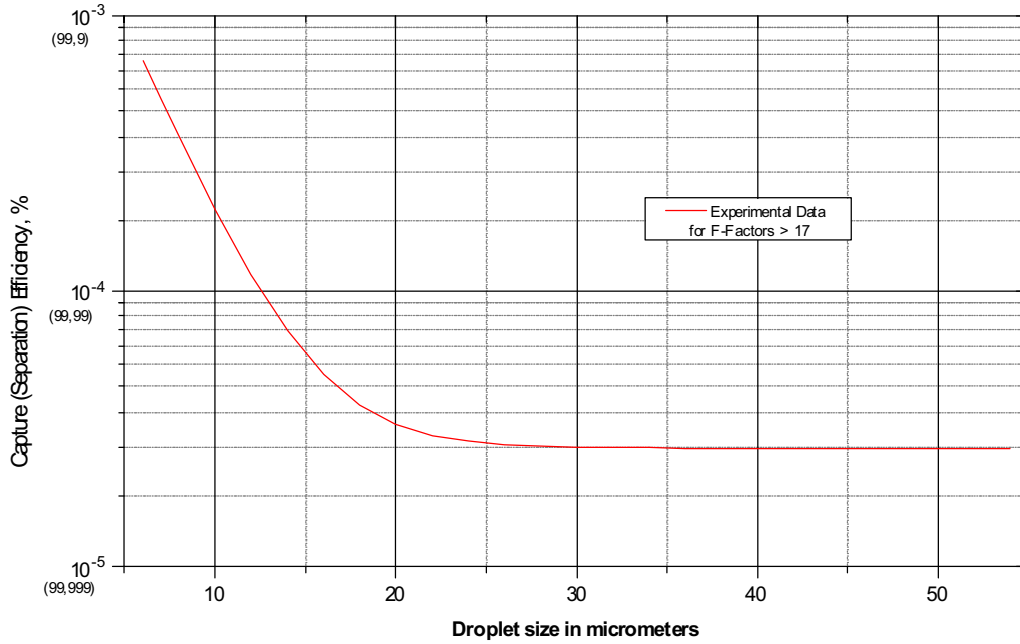

Gas Throughput for 1 Separating Element (SE) vs. Pressure for various F-Factors

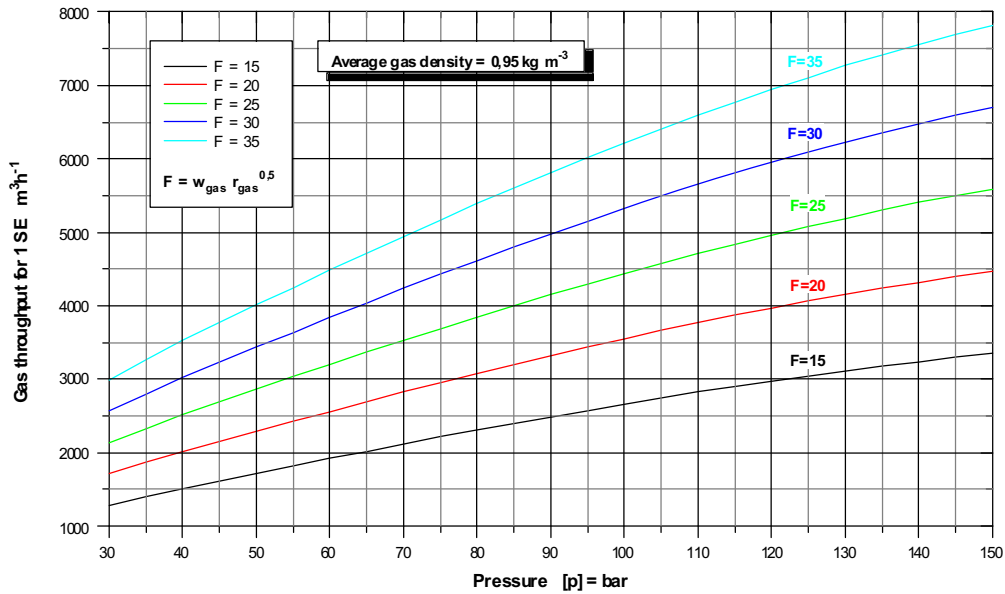



Multi Cyclones

INTRODUCTION

HAT's AlphaMIST® MCE multi-cyclone elements are designed specifically for the removal of high levels of liquids and solids from gas in a single separation stage. Separation efficiency is from this single stage device is reasonable, although if very high efficiency is required then a second stage mist eliminator is sometimes needed.

The design combines high gas velocity, high liquid capacity and low to medium pressure drop.

The advantages of the AlphaMIST MCE's are:

- Effective separation of particles above 25 microns, even at high pressures
- Very high gas and liquid capacities at high gas velocities
- The mist may contain solid particles
- The MCE is foam-breaking due to its special design
- Low or medium pressure drop (25-75 mbar)
- Reduce the vessel size and weight especially in high pressure applications
- Easy to install
- Retrofits easily into existing vessels / scrubbers to give extra capacity
- The units have no moving parts and are maintenance free



Typical MCE Cluster

MCE Applications

The multi-cyclone element design provides optimal performance of entrainment separation at high gas capacities at pressures from 10 up to 200 bar. Common applications include:

- Pipeline separators for removing pipescale and liquid spray
- Upstream bulk separators prior to filter-separators
- Compact Gas/Oil separators
- Compressor suction and discharge scrubbers

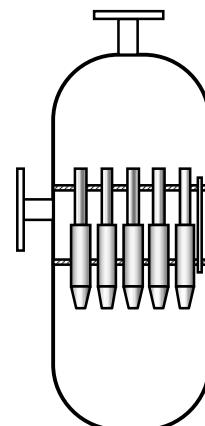



Multi Cyclones

Multi Cyclone Element Construction

The installed unit consists of special separating elements fixed between two partition plates with openings for gas risers and the separated liquid. Where low turndown is required (below approx 40%) we recommend a secondary gas/liquid coalescer device is installed.

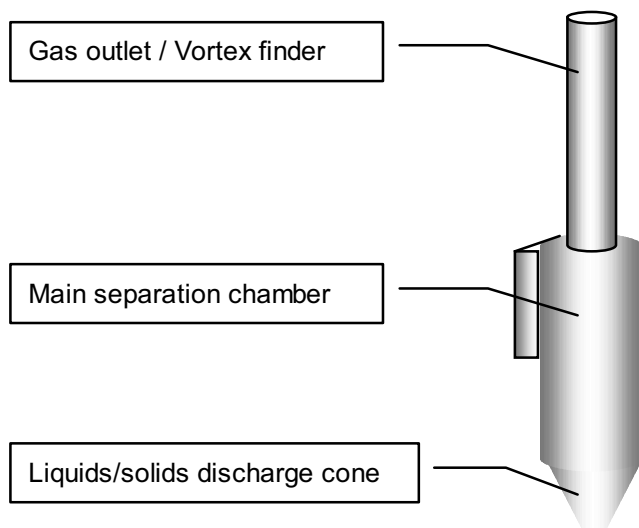

Each cyclone element consists of an outer tube with integral swept inlet nozzle to initiate the spin.

In the initial region the inlet fluid is accelerated at high speed into a cyclonic swirl so that the liquid droplets and solids are flung to the tube wall where they impinge and are swept downwards with the gas.

The core of this element is fitted with a central vortex finder/gas outlet pipe so that the gas reverses its flow to rise up this tube, leaving behind the liquid and solid contaminants that cling to the cyclone wall.

These contaminants continue their path downwards into the tapered section of the cyclone where they exit into the lower chamber of the vessel for drainage

The MCE elements are available in a range of materials including carbon steel, stainless steels and higher alloys.